

TRANSMISSIÓ I TRANSFORMACIÓ DEL MOVIMENT

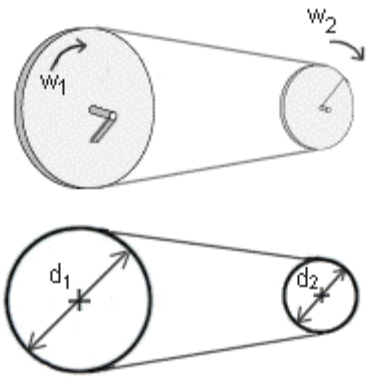

politges

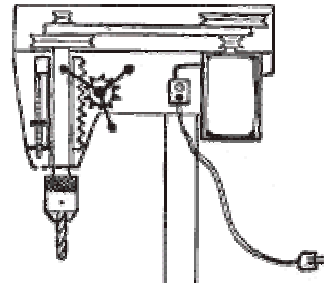

caixa de canvis trepant de sobretaula



Plats i pinyons bicicleta

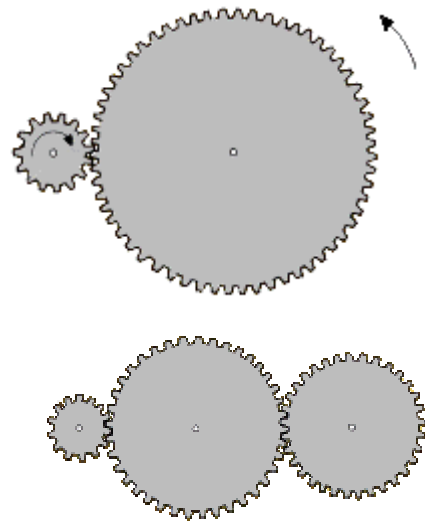
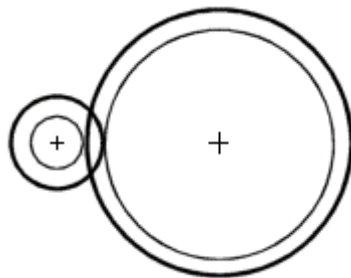

representació gràfica engranatges

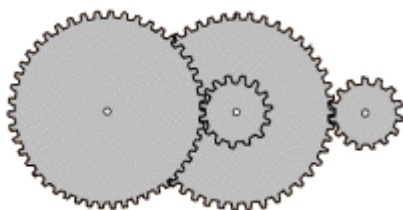

tren d'engranatges



engranatge recte

engranatge helicoidal



engranatge cònic

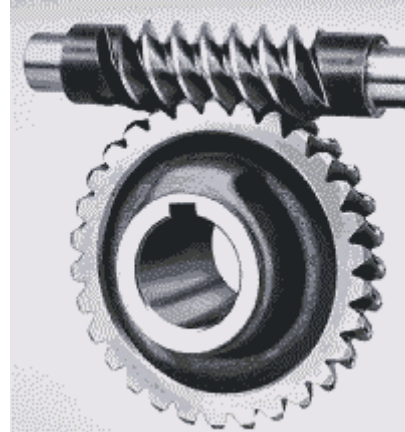

vis sense fi



engranatge de cremallera

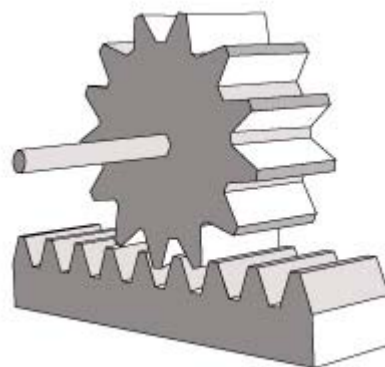

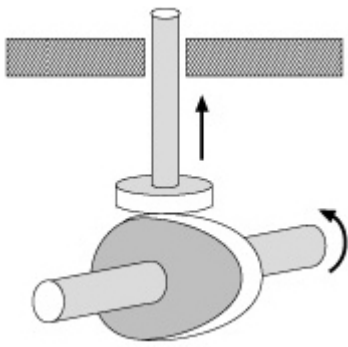

lleva

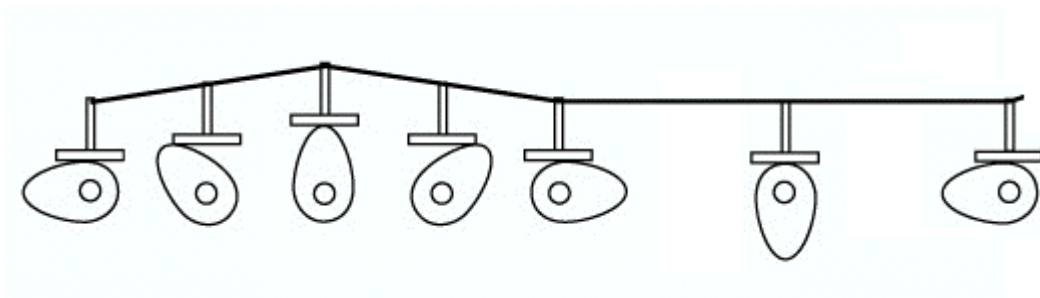

Obertura i tancament de vàlvules d'admissió i tancament motor combustió

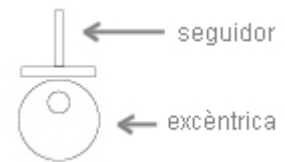

excèntrica



Cargol-femella

biela-manovella

